

INSTRUCTION MANUAL FOR



RUGER-5.7™ PISTOL PRO MODEL*



*** DO NOT USE THIS MANUAL
FOR PISTOLS EQUIPPED WITH
A MANUAL SAFETY**

– Rugged, Reliable Firearms® –



**READ THE INSTRUCTIONS AND
WARNINGS IN THIS MANUAL CAREFULLY
BEFORE USING THIS FIREARM**

© 2022 Sturm, Ruger & Co., Inc.

This manual may not be reproduced in whole or in part without the express written permission of Sturm, Ruger & Co., Inc.

**For Service on This Model Please Call:
(336) 949-5200 (See p. 38)**

THIS INSTRUCTION MANUAL SHOULD ALWAYS ACCOMPANY THIS FIREARM AND BE TRANSFERRED WITH IT UPON CHANGE OF OWNERSHIP, OR WHEN THE FIREARM IS LOANED OR PRESENTED TO ANOTHER PERSON

Ruger.com

R-5.7 PRO 3/2022 R1

State-By-State Warnings

Certain states require by law that their own specified warning notices in larger-than-normal type be conspicuously included by the manufacturer, distributor or retailer with firearms sold in that state. Sturm, Ruger & Co., Inc. sells its products in compliance with applicable laws and regulations. Because our products may be sold in these states, we include the following:

California:

WARNING

“Firearms must be handled responsibly and securely stored to prevent access by children and other unauthorized users. California has strict laws pertaining to firearms, and you may be fined or imprisoned if you fail to comply with them. Visit the Web site of the California Attorney General at <https://oag.ca.gov/firearms> for information on firearm laws applicable to you and how you can comply.

Prevent child access by always keeping guns locked away and unloaded when not in use. If you keep a loaded firearm where a child obtains and improperly uses it, you may be fined or sent to prison.

If you or someone you know is contemplating suicide, please call the national suicide prevention lifeline at 1-800-273-TALK (8255).”

ADVERTENCIA

“Las armas de fuego deben manipularse de manera responsable y segura para evitar el acceso de niños y otros usuarios no autorizados. California tiene leyes estrictas relacionadas con armas de fuego, y usted puede ser multado o encarcelado si no las cumple. Visite el sitio web del Procurador General de California en <https://oag.ca.gov/firearms> para obtener información sobre las leyes de armas de fuego que le son aplicables y cómo puede cumplirlas.

A los niños los atraen las armas de fuego y las pueden hacer funcionar. Ellos pueden causarse lesiones graves y la muerte. Evite que los niños tengan acceso a las armas de fuego guardándolas siempre con llave y descargadas cuando no las esté utilizando. Si usted tiene un arma de fuego cargada en un lugar en que un niño tiene acceso a ella y la usa indebidamente, le pueden dar una multa o enviarlo a la cárcel.

Si usted o alguien que conoce está pensando en suicidarse, llame a la línea nacional de prevención del suicidio al 1-800-273-TALK (8255).”

Connecticut:

“UNLAWFUL STORAGE OF A LOADED FIREARM MAY RESULT IN IMPRISONMENT OR FINE.”

Florida:

“IT IS UNLAWFUL, AND PUNISHABLE BY IMPRISONMENT AND FINE, FOR ANY ADULT TO STORE OR LEAVE A FIREARM IN ANY PLACE WITHIN THE REACH OR EASY ACCESS OF A MINOR UNDER 18 YEARS OF AGE OR TO KNOWINGLY SELL OR OTHERWISE TRANSFER OWNERSHIP OR POSSESSION OF A FIREARM TO A MINOR OR A PERSON OF UNSOUND MIND.”

Maine:

“ENDANGERING THE WELFARE OF A CHILD IS A CRIME. IF YOU LEAVE A FIREARM AND AMMUNITION WITHIN EASY ACCESS OF A CHILD, YOU MAY BE SUBJECT TO FINE, IMPRISONMENT OR BOTH. KEEP FIREARMS AND AMMUNITION SEPARATE. KEEP FIREARMS AND AMMUNITION LOCKED UP. USE TRIGGER LOCKS.”

Maryland:

“WARNING: Children can operate firearms which may cause death or serious injury. It is a crime to store or leave a loaded firearm in any location where an individual knew or should have known that an unsupervised minor would gain access to the firearm. Store your firearm responsibly!”

Massachusetts:

“WARNING FROM THE MASSACHUSETTS ATTORNEY GENERAL: This handgun is not equipped with a device that fully blocks use by unauthorized users. More than 200,000 firearms like this one are stolen from their owners every year in the United States. In addition, there are more than a thousand suicides each year by younger children and teenagers who get access to firearms. Hundreds more die from accidental discharge. It is likely that many more children sustain serious wounds, or inflict such wounds accidentally on others. In order to limit the chance of such misuse, it is imperative that you keep this weapon locked in a secure place and take other steps necessary to limit the possibility of theft or accident. Failure to take reasonable preventive steps may result in innocent lives being lost, and in some circumstances may result in your liability for these deaths.”

“IT IS UNLAWFUL TO STORE OR KEEP A FIREARM, RIFLE, SHOTGUN OR MACHINE GUN IN ANY PLACE UNLESS THAT WEAPON IS EQUIPPED WITH A TAMPER-RESISTANT SAFETY DEVICE OR IS STORED OR KEPT IN A SECURELY LOCKED CONTAINER.”

New Jersey:

“IT IS A CRIMINAL OFFENSE TO LEAVE A LOADED FIREARM WITHIN EASY ACCESS OF A MINOR.”

New York:

“THE USE OF A LOCKING DEVICE OR SAFETY LOCK IS ONLY ONE ASPECT OF RESPONSIBLE FIREARM STORAGE. FOR INCREASED SAFETY, FIREARMS SHOULD BE STORED UNLOADED AND LOCKED IN A LOCATION THAT IS BOTH SEPARATE FROM THEIR AMMUNITION AND INACCESSIBLE TO CHILDREN AND UNAUTHORIZED PERSONS.”

North Carolina:

“IT IS UNLAWFUL TO STORE OR LEAVE A FIREARM THAT CAN BE DISCHARGED IN A MANNER THAT A REASONABLE PERSON SHOULD KNOW IS ACCESSIBLE TO A MINOR.”

Texas:

“IT IS UNLAWFUL TO STORE, TRANSPORT, OR ABANDON AN UNSECURED FIREARM IN A PLACE WHERE CHILDREN ARE LIKELY TO BE AND CAN OBTAIN ACCESS TO THE FIREARM.”

Wisconsin:

“IF YOU LEAVE A LOADED FIREARM WITHIN THE REACH OR EASY ACCESS OF A CHILD YOU MAY BE FINED OR IMPRISONED OR BOTH IF THE CHILD IMPROPERLY DISCHARGES, POSSESSES, OR EXHIBITS THE FIREARM.”

* * * * *

Please check with your licensed retailer or state police for additional warnings which may be required by local law or regulation. Such regulations change constantly, and local authorities are in the best position to advise you on such legal matters.

FIREARMS SAFETY IS YOUR RESPONSIBILITY

SAFETY MUST BE THE FIRST AND CONSTANT CONSIDERATION OF EVERY PERSON WHO HANDLES FIREARMS AND AMMUNITION.

This instruction manual is designed to assist you in learning how to use and care for your **RUGER-5.7™ PISTOL** without manual safety properly. Please contact us if you have any questions.

Only when you are certain you fully understand the manual and can properly carry out its instructions should you practice loading, unloading, etc. with live ammunition. If you have any doubts about your ability to handle or use a particular type of firearm safely, you should seek supervised instruction. Such personalized instruction often is available from local firearm retailers, gun clubs or police departments. If none of these sources can help, visit nra.org or write to the following address:

National Rifle Association
11250 Waples Mill Road
Fairfax, VA 22030-7400

The person possessing a firearm has a full-time job. You cannot guess; you cannot forget. You must know how to use your firearm safely. **Do not use any firearm without having a complete understanding of its particular characteristics and safe use.** Remember: There is no such thing as a foolproof firearm.

TABLE OF CONTENTS

	Page
State-By-State Warnings	3
Nomenclature	9
Locking Device Installation Instructions	10
General Information and Mechanical Characteristics	12
Operation of Slide Stop	14
Operation of Magazine Release	15
Ammunition	17
Magazines	18
Dry Firing	19
To Load and Fire	20
Visual Inspection of View Port	22
To Reload the Pistol	23
To Unload	23
To Clear a Malfunction (“Jam” or “Misfire”)	25
To Minimize Malfunctions (“Jams” or “Misfires”)	26
Disassembly	26
Reassembly	31
Check Your Pistol’s Function	33
To Clean and Lubricate	34
Inspection and Maintenance	36
Sight Adjustment	36
Accessory Optics	37
Storage	37
Service and Parts Policy	38
Shipping Firearms for Repair	38
Ordering Parts	39
Parts List	40
Exploded View	41
The Basic Rules of Safe Firearms Handling	42
Warranty Information	48

“Ruger” is a registered U.S. trademark of Sturm, Ruger & Co., Inc.



WARNINGS OF GREAT IMPORTANCE ARE FOUND ON THE FOLLOWING PAGES:

Locking Devices	10	Unloading	24
Alterations	12	Malfunctions	25
Ammunition	17	Disassembly	26
Lead Exposure	17	Lubrication	36
Slide Retraction	21	Storage	37
Firing	21	Shipping	38
Handling	22	Parts Purchasers	39
Use of View Port	22		

**OTHER CAUTIONS AND WARNINGS APPEAR
THROUGHOUT THE MANUAL.**

NOMENCLATURE

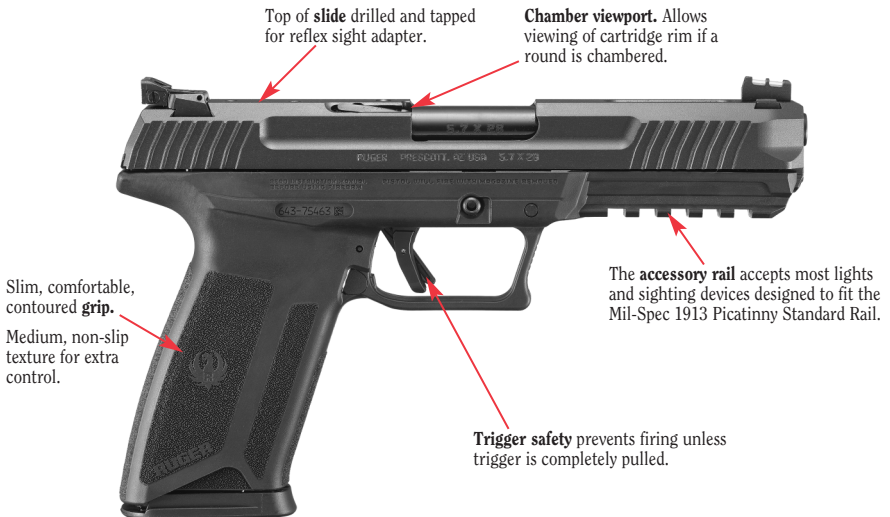

LOCKING DEVICE INSTALLATION INSTRUCTIONS



WARNING – USE OF LOCKING DEVICES



**Do not store keys
in lock.**

- Always keep your firearm pointed in a safe direction, including when you are installing or removing your locking device.
- Always verify that your firearm is completely **unloaded** (see pg. 23) before installing your locking device.
- Do **not** install locking devices in the trigger guard; always keep your fingers and locking device outside the trigger guard during device installation and removal.
- Store firearms, ammunition and keys separately and securely, away from children and careless adults; do **not** store your firearm with the keys in the locking device.
- Do not attempt to work the action of your firearm with the locking device in place; this may damage your firearm.
- While locking devices are an important aid to security measures, they are not a substitute for safe firearm handling and proper storage. Remember that any mechanical device can be bypassed with enough time, knowledge, determination and equipment.

**LOCKING DEVICES MUST BE USED
SAFELY AND RESPONSIBLY**

It is important to use the locking device on your Ruger® firearm!

Keep the muzzle pointed in a safe direction and your fingers outside the trigger guard at all times during installation of the locking device!

To Install the Factory-Supplied Locking Device:

1. Remove the magazine from your pistol.
2. Open the action completely, and verify that the firearm is completely unloaded and contains no cartridges or cartridge cases!

To keep the action open during installation of the locking device, hold the pistol firmly and grasp the slide. Retract the slide to its rearmost position briskly to extract and eject any chambered cartridge. Always visually double-check that the chamber, breech-face, and the interior of the frame are clear of any live rounds. When the slide is fully retracted, push upward on the slide stop, then allow the slide to move forward until it comes to rest with the rear projection of the slide stop resting in the notch on the lower left side of the slide.

3. Insert the cable into your pistol as shown in Figure 1.
4. To lock: With the key turned to the farthest clockwise position, insert the loose end of the cable into the lock. Turn the key counterclockwise and remove the key.
5. Once the lock is securely closed, pull firmly on the lock to test the connection and be sure it is locked. **Do not leave or store your firearm with the key in the lock!** Store your locked, unloaded firearm and the key in secure, separate locations, away from ammunition, children, and unauthorized adults.



Figure 1

Correct installation of the lock on a RUGER-5.7™ pistol.

**FIREARMS ARE DANGEROUS WEAPONS.
READ THE INSTRUCTIONS AND WARNINGS
IN THIS MANUAL THOROUGHLY AND
CAREFULLY BEFORE USING.**

 WARNING - ALTERATIONS	
	This product was designed to function properly in its original condition. Alterations can make it unsafe. Do not alter any part or add or substitute parts or accessories not made or sold by Sturm, Ruger & Co., Inc.
	DO NOT ALTER ANY FIREARM

GENERAL INFORMATION AND MECHANICAL CHARACTERISTICS

The **RUGER-5.7™** pistol without manual safety is an internally hammer-fired, magazine-fed, autoloading, recoil-operated, centerfire handgun. The **RUGER-5.7™** pistol features a Secure Action fire control similar to the **LCP® II** and **SECURITY-9®** pistols. Ruger's safe, reliable, and proven Secure Action™ fire-control system combines a protected internal hammer with a bladed safety trigger. The hammer and sear are designed to engage with significant mechanical overlap. This requires additional cocking of the hammer during trigger pull and keeps the hammer and sear securely engaged under the full force of the hammer spring. Additionally, a neutrally balanced sear and strong sear spring ensure continuous, positive engagement of the hammer. The trigger has a short, smooth pull, clean break and positive reset. Despite longer cartridges, the steel magazines and high strength glass fiber nylon grip frame provide a slim, comfortable grip not much larger than most 9mm double-stack pistols. The textured grip frame provides a secure gripping surface in all conditions. The **RUGER-5.7™** pistol features a reversible magazine release. It also features: easy no-trigger-pull, tool-less take-down; steel sights; and an accessory rail. The alloy steel slide has front and rear cocking serrations, lightening cuts and it comes drilled and tapped for accessory reflex sight mounting systems. The frame insert is precision CNC machined aluminum with integral frame rails. Specific features and options may vary between models.

The **RUGER-5.7™** pistol utilizes a delayed blowback design in which the barrel and slide are held together by the recoil spring at the moment of firing. Depressing the trigger safety allows the trigger to fully travel rearward. The trigger bar transfers this movement to the sear which rotates in contact with the hammer, compressing the hammer spring until the sear disengages and allows the hammer to fall against the firing pin and ignite the primer. As the bullet moves down the barrel and exits, the barrel and slide move rearward at different speeds until the barrel reaches its stopping point. The recoiling slide pushes down the trigger bar, disconnecting it from the sear.

The slide continues rearward with the extractor pulling the spent cartridge case from the chamber and cocking the internal hammer. After the slide reaches full rearward travel, the compressed recoil spring begins to push the slide forward. The slide picks up the top cartridge from the magazine, pushing it into the chamber and pushing the barrel into the forward position. Releasing the trigger allows the trigger bar to move back into position, resetting the pistol to its ready-to-fire condition.

Safety features include: integrated trigger safety to block the trigger unless it is intentionally pulled; neutrally balanced sear with significant engagement and strong spring tension; and hammer catch to help prevent the hammer from contacting the firing pin unless the trigger is pulled.

The user of this or any autoloading pistol must always remember that when fired, it automatically reloads and re-cocks itself, so that simply pulling the trigger will fire the pistol again. Removing the magazine does not prevent the pistol from firing. The firearm can be fired with the magazine removed if there is a round in the chamber. Therefore, an autoloading pistol user must be particularly conscious to always keep the pistol pointed in a safe direction.

OPERATION OF SLIDE STOP

When the last shot has been fired and the magazine is empty, the slide stop automatically holds the slide open. Likewise, fully retracting the slide manually when there is an empty magazine in the pistol will also hold the slide open. To lock the slide to the rear when there is a loaded magazine inserted in the pistol, or no magazine in the pistol, first point the pistol in a safe direction then fully retract the slide with the non-firing hand while pushing up on the bottom of the slide stop with the firing hand (see Figure 2). If a round was chambered, it should extract and eject as you retract the slide manually. Once the slide is locked back, visually inspect the chamber to ensure it is empty.

To release the slide, first remove the empty magazine and then simply pull the slide back with the non-firing hand and let it go (see Figure 3). If a loaded magazine is inserted, pulling the slide back and letting it go will chamber a round. Keep your fingers away from the trigger and keep the muzzle pointed in a safe direction.

CAUTION: When there is a loaded magazine in place and the pistol is jarred, the slide stop may release, causing the slide to fly forward and chamber a cartridge. For this reason and as an essential safety practice, the user should always be careful to keep fingers away from the trigger, and always keep the pistol pointed in a safe direction.

Figure 2



Figure 3



OPERATION OF MAGAZINE RELEASE

When a magazine is fully inserted into the magazine well, it is automatically held in place by the spring loaded magazine latch. The magazine release is the button to the rear of the trigger guard. When depressed, the magazine release will permit removal of the magazine from the pistol. Under normal conditions, the magazine will fall free of the pistol when the magazine release is depressed. To avoid damage and debris entering the magazine, do not let it fall to the ground. In the event the magazine becomes stuck in the magazine well, it can be manually extracted by pressing the magazine release while pulling on the magazine base pad (see Figure 4).



WARNING: Removing the magazine does not prevent the pistol from firing. The firearm can be fired with the magazine removed if there is a round in the chamber. Therefore, an autoloading pistol user must be particularly conscious to always keep the pistol pointed in a safe direction and keep fingers out of the trigger guard and away from the trigger when not firing.

Reversible Magazine Release:

The magazine release button for the **RUGER-S.7™** pistol is reversible for operation by the thumb or forefinger of either hand.

To switch the button from one side to the other, the slide must be removed to provide access to the magazine latch inside the magazine well (see “Disassembly” instructions p. 27, steps 1 - 5).

1. Use any non-marring tool, such as a wooden dowel, to press on the flush non-protruding side of the magazine release button. The button will come free of the grip frame. (See Figures 5a & 5b.)

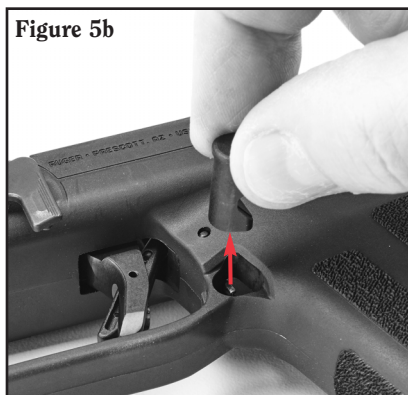

2. The magazine release button may be reinserted on the opposite side of the grip frame with finger pressure to pop it into place while depressing the magazine latch inside the magazine well. (See Figure 6.)

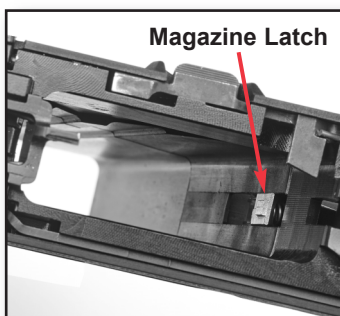

3. Reinstall the slide (see “Reassembly” instructions pp. 32 - 33, steps 5 - 8).

AMMUNITION

Be certain to use the correct cartridge for your pistol, and do not attempt to load any other cartridges into the magazine or chamber of the pistol other than what is specified.

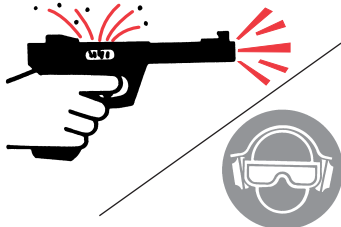

The **RUGER-5.7™** pistol is compatible with newly loaded factory ammunition conforming to C.I.P. standard dimensions and pressures for 5.7x28mm ammunition. No “+P” or “+P+” ammunition should ever be used in this firearm.

No reloaded ammunition should ever be used in this firearm. The use of non-conforming, reloaded, or specialty ammunition may reduce reliability or cause damage or injury.

 WARNING – AMMUNITION	
	<p>Use only new, factory ammunition of the correct caliber.</p> <p>Death, serious injury, and damage can result from the wrong ammunition, bore obstructions, powder overloads or incorrect cartridge components.</p> <p><u>Always</u> wear shooting glasses and hearing protection.</p>
IMPROPER AMMUNITION DESTROYS FIREARMS	

AMMUNITION (CARTRIDGES) NOTICE

WE SPECIFICALLY DISCLAIM RESPONSIBILITY FOR ANY DAMAGE OR INJURY WHATSOEVER OCCURRING IN CONNECTION WITH, OR AS A RESULT OF, THE USE IN RUGER FIREARMS OF FAULTY, OR NON-STANDARD, OR “RE-MANUFACTURED”, OR HAND-LOADED (RELOADED) AMMUNITION OR OF CARTRIDGES OTHER THAN THOSE FOR WHICH THE FIREARM WAS ORIGINALLY CHAMBERED.

 WARNING - LEAD EXPOSURE	
	<p>Discharging firearms in poorly ventilated areas, cleaning firearms, or handling ammunition may result in exposure to lead and other substances known to the State of California to cause birth defects, reproductive harm, and other serious physical injury. Have adequate ventilation at all times. Wash hands thoroughly after exposure.</p>
SHOOTING OR CLEANING FIREARMS MAY EXPOSE YOU TO LEAD	

MAGAZINES

Use only **GENUINE RUGER® FACTORY** magazines designated for your firearm. The use of incorrect magazines in any pistol will result in malfunctions. Check the magazine frequently. The magazine follower must move freely and have adequate tension so that each cartridge is quickly raised to the feeding position. The magazine feed lips should be clean and free of cracks so that cartridges are held in their proper feeding position. If damage is present, the magazine should be replaced. **NOTE:** The rear dents on each side of the feed lips help retain the rim of the cartridge and are normal.

To load the magazine, press cartridges straight down through the feed lips, one at a time until the magazine is full.

Ensure the top cartridge is fully seated against the rear of the magazine. (See Figure 7b.)

To unload the magazine, slide each cartridge forward and out of magazine, one at a time, until the magazine is empty.

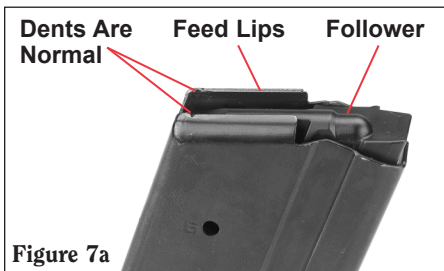

If the magazine becomes dirty, it should be disassembled and thoroughly cleaned. Be sure the magazine is unloaded before disassembly. Use a punch to press in on the magazine spring seat where it protrudes into the hole in the magazine floorplate (see Figure 8). Slide the magazine floorplate toward the front of the magazine. **CAUTION: The magazine spring is under heavy spring tension.** Be careful to prevent the forcible ejection of the magazine spring seat and compressed magazine spring by retaining them with your hand while removing the floorplate (see Figure 9). Withdraw the magazine spring seat, magazine spring, and magazine follower from the magazine body.



Reassemble the magazine in the reverse order making sure that the spring and follower are oriented as shown in Figure 10.

Insert the magazine spring with the magazine spring seat parallel to the base of the magazine body.

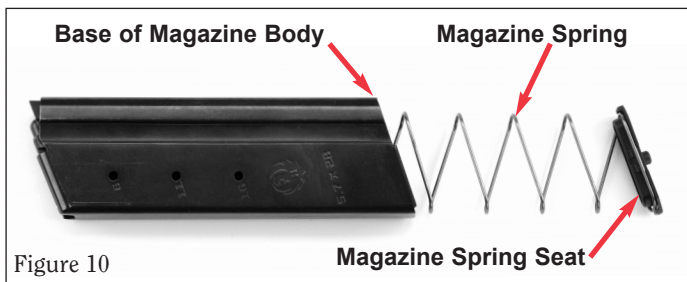

Figure 10

DAMAGED, NON-STANDARD OR IMPROPERLY ASSEMBLED MAGAZINES SHOULD NOT BE USED. THEY CAN CAUSE THE PISTOL TO MALFUNCTION.

Clean all magazine components with a brush or rag to remove residue. You may use a suitable solvent that will not rust the metal components or adversely affect the magazine body. After cleaning, remove all excess solvent from the magazine components. A few drops of light oil applied to a lint free cloth and wiped on the magazine body and spring will prevent rust. It is not necessary to lubricate the magazine.

WARNING: Penetrating oils and solvents inside a magazine can “kill” or weaken cartridge primers or powder which can result in failures to fire or other possibly dangerous malfunctions, such as leaving a bullet in the bore!

After cleaning and reassembling the magazine, always check to be certain that the magazine follower moves freely and forcefully to the top of the magazine and that no solvent or debris remain. Improper reassembly of the magazine can cause malfunctions.

DRY FIRING

Going through the actions of cocking, aiming and pulling the trigger on an unloaded firearm is known as “dry firing.” It can be useful to learn the “feel” of your pistol. Be certain that the pistol is fully unloaded (both the chamber and magazine are empty) and that the pistol is pointing in a safe direction when you are practicing dry firing. The **RUGER-5.7™** pistol can be dry fired without damage to the firing pin or other components.

The firearm should never be dry fired while the slide is removed or the take-down lever is in the “unlocked” position. This could result in damaging the ejector.

NOTE: When dry firing the **RUGER-5.7™** pistol, the trigger mechanism will not reset unless the slide is retracted at least 1/2”.

TO LOAD AND FIRE

Before you attempt to load and fire the pistol, first read through this manual completely and be certain you understand the pistol's operation.

Before each firing session, visually inspect the firearm and its magazine to ensure no components are damaged, missing, loose, bent, cracked, chipped, or peened. Ensure the firearm is free of dirt, dust, sand, lint, or environmental debris. The firearm should be clean and lightly lubricated in accordance with the instructions. You should also perform a function check (see page 33) on the unloaded firearm to ensure it operates properly and that all safety devices are in proper working order.

1. **Be certain the muzzle is pointed in a safe direction.** (See “The Basic Rules of Safe Firearms Handling,” page 42.)
2. Pull the slide fully to the rear until the slide stops and lock it open by pushing upward on the slide stop (see Figure 11).

Figure 11

**Retract Slide & Lock
Back With Slide Stop**

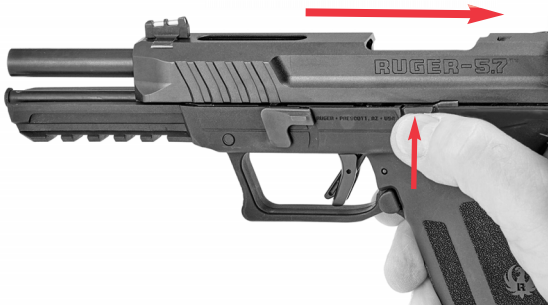

3. Insert a loaded magazine into the grip frame, taking care that the magazine is locked in place by the magazine latch. Slamming the magazine into the frame forcibly is not necessary.
4. Hold the pistol firmly in the shooting hand with your fingers away from the trigger. Keep the pistol pointed in a safe direction. With the other hand, grasp the rear of the slide and pull the slide to the rear as far as it will go (see “Slide Retraction Warning,” p. 21). When released, the slide will fly forward from the magazine and chamber it.

WARNING: The pistol is now ready for instant use. Be careful!

5. The first shot can be fired by pulling the trigger all the way to the rear. Subsequent shots are fired one at a time by repeated pulling of the trigger until the magazine is empty.

! WARNING - SLIDE RETRACTION

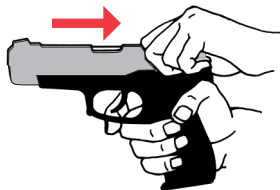

The slide should always be pulled rearward (“retracted”) by pulling the rear portion of the slide. **Always keep fingers away from trigger!**

Never put any part of your hands or body over the muzzle while retracting the slide for loading, unloading, inspection, or clearing a malfunction.

**KEEP HANDS
AWAY FROM MUZZLE AND
FINGER OFF TRIGGER**

! WARNING - FIRING



The slide automatically opens and shuts quickly while firing. Keep face and hands away from rear. Hot brass is ejected quickly and can burn you. Always wear shooting glasses and hearing protection.

**SLIDE OPENS FAST -
HOT BRASS EJECTED**

- At any time, if the pistol is not being fired, keep it pointed in a safe direction (downrange). **If the pistol is not to be used immediately, the magazine should be removed and the chamber unloaded.**
- When the last cartridge in the magazine has been fired, the empty magazine will activate the slide stop and hold the slide open. If the slide is shut, the shooter should always assume that there is a cartridge in the chamber!

DO NOT rely on your memory or the word of others to know if a firearm or magazine is loaded. With the pistol pointed in a safe direction, visually inspect the magazine and chamber.

NOTE on Chamber Checks: Hold the pistol at an angle where you can clearly see the chamber in the rear of the barrel. If you cannot clearly see the chamber with the slide fully retracted, you can manually control the slide and ease it forward to get a better view of the chamber then lock it back with the slide stop.

WARNING - HANDLING



Do not load the pistol until you are ready to use it, and unload it immediately when you have completed shooting. (See "Warning - Unloading" on page 24.)

If dropped or struck, the pistol may fire. Keep chamber empty unless actually firing!

For maximum safety when carrying the pistol with a loaded magazine in place, the chamber should be empty, and the slide should be closed. If placed into a holster, check it to be sure that the slide is not retracted far enough to chamber a cartridge from the magazine.

The user should never depend on any mechanical device to justify careless handling or permitting the pistol to point in an unsafe direction. The shooter should always be alert to the possibility of accidental discharge. **The only absolutely safe pistol is one in which the slide is open, the chamber is empty, and there is no magazine in the firearm.**

ANY FIREARM MAY FIRE IF DROPPED

VISUAL INSPECTION OF VIEW PORT

You should always treat every firearm as though it is loaded and always keep the muzzle pointed in a safe direction. Never rely upon any safety or mechanical device to justify unsafe or careless firearm handling. In order to assist you in determining the presence of a cartridge in the chamber of your **RUGER-S.7™** pistol, there is a view port in the slide, next to the extractor, that allows the user to look in and see the rim of the cartridge if one is present in the chamber (see Figure 12).

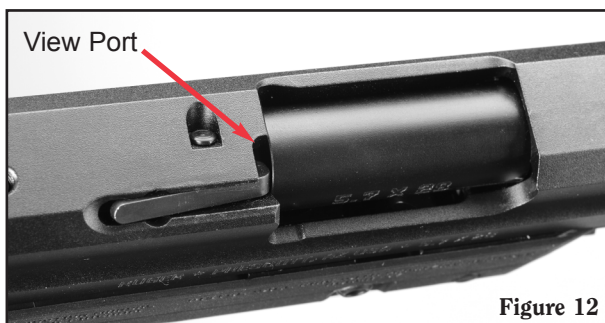

Figure 12



NEVER RELY ON YOUR MEMORY, LOADED CHAMBER INDICATOR OR VIEW PORT TO KNOW IF A FIREARM IS LOADED. ANY MECHANICAL DEVICE CAN FAIL. ALWAYS VISUALLY CHECK THE CHAMBER BY RETRACTING THE SLIDE AND EXAMINING THE CHAMBER TO BE SURE WHETHER IT IS EMPTY OR LOADED.



TO RELOAD THE PISTOL

1. Firing all cartridges in the magazine and the chamber will cause the slide to automatically lock open. **Keep the pistol pointed in a safe direction.** Press in on the magazine release. The magazine will fall free of the pistol. To avoid damage and debris entering the magazine, do not let it fall to the ground.
2. Insert a loaded magazine. **WARNING: When there is a loaded magazine in place and the pistol is jarred, the slide can fly forward and chamber a cartridge. For this reason and as an essential safety practice, the pistol should always be pointed in a safe direction.**
3. Release the slide by pulling the slide fully to the rear and releasing it. A cartridge will be chambered when the slide shuts.
WARNING: The pistol is ready to fire.
4. When you are finished firing the pistol, unload it completely (see “To Unload” instructions below).

TO UNLOAD

WARNING: This sequence must be followed exactly as outlined. Failure to do so can result in the chamber being unintentionally loaded with a live cartridge! Removing the magazine does not prevent the pistol from firing. The firearm can be fired with the magazine removed if there is a round in the chamber.

1. **The muzzle of the pistol must be pointing in a safe direction at all times and fingers must remain outside of the trigger guard away from the trigger.**
2. Press the magazine release button to release the magazine. To avoid damage and debris entering the magazine, do not let it fall to the ground.
REMEMBER that even though the magazine has been removed, a live round may remain in the chamber. (See “Warning - Unloading,” p. 24.)
3. Grip the pistol firmly with the firing hand and grasp the slide with the non-firing hand. Retract the slide to its rearmost position briskly to extract and eject any chambered cartridge and hold the slide to the rear. When the slide is fully retracted, push upward on the slide stop, then allow the slide to move forward until it comes to rest with the rear projection of the slide stop resting in the notch on the lower left side of the slide.
4. Always visually double-check that the chamber, breech-face, and the interior of the frame are clear of any live rounds and no magazine is inserted.

 WARNING - UNLOADING	
	<p>Removing the magazine does not unload the pistol! To unload, first remove the magazine, then pull the slide to the rear, eject the chambered cartridge, and visually inspect the chamber to be sure it is empty. Always point the pistol in a safe direction when loading or unloading.</p> <p>Removing the magazine DOES NOT prevent the pistol from firing – never rely on any mechanical safety device to justify careless handling of any firearm.</p>
REMOVING MAGAZINE DOES NOT UNLOAD CHAMBER	

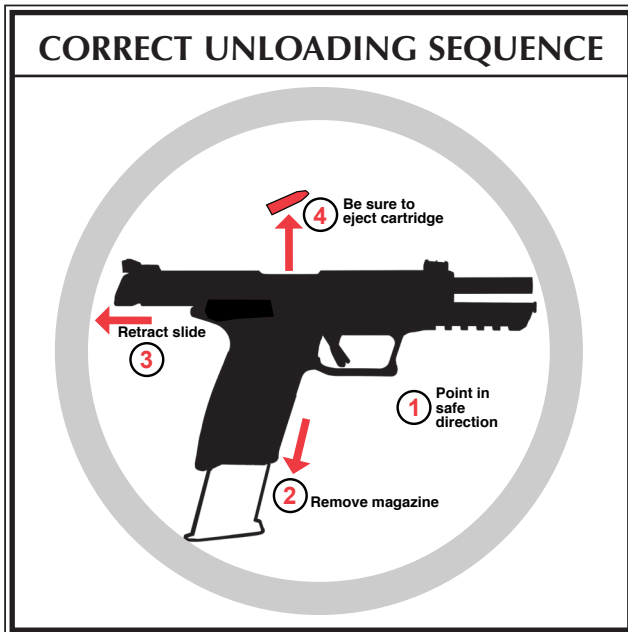

At this point you may insert the included cable lock for storage (See “Locking Device Installation Instructions,” p. 10) or:

5. To close the slide, pull the slide to its rearmost position and release it. The slide will snap forward. Keep fingers out of ejection port on top of the slide!
6. Point the empty pistol in a safe direction and dry fire the trigger to release tension on the internal hammer.



TO CLEAR A MALFUNCTION ("JAM" or "MISFIRE")

1. Be certain the muzzle is continually pointed in a safe direction. Keep fingers out of the trigger guard.
2. If the misfire is the result of a cartridge not firing or unusual report (either louder or quieter than normal), keep the pistol pointed in a safe direction for 30 seconds prior to ejecting the chambered round or retracting the slide.
3. If possible, remove the magazine. It may be necessary to manually remove a jammed cartridge that has only been partially stripped from the magazine. If so, use extreme care. Lock the slide open with the slide stop before attempting to clear the jam. Drawing the slide fully to the rear may bring the jammed cartridge along. **Keep your face away from the ejection port during this operation.** When attempting to clear a jam, use only wood "tools" so that the cartridge will not be damaged or the primer ignited. A 3/16" wooden dowel with a point on one end is useful.
4. Visually check to make sure that all cartridges have been removed from the pistol. Safely dispose of any cartridges involved in a malfunction incident. Do not use damaged ammunition in any firearm.
5. Using a cleaning rod, inspect the bore and chamber to ensure that they are not obstructed. **Failure to detect and correctly remove a bore obstruction can result in serious injury!**

 WARNING - MALFUNCTIONS	
	<p>Any autoloading pistol may occasionally malfunction. If a cartridge hangs up, jams, or binds when being chambered, do not attempt to force it into the chamber by pushing or striking the slide. Carefully remove it.</p> <p>Most failures of a cartridge to feed or to chamber properly are caused by a damaged magazine, incorrect firearm handling, insufficient lubrication, or improper ammunition.</p> <p>Whatever the cause, the user of the pistol must, above all, recognize that any cartridge jam can result in a potentially very dangerous situation of a cartridge discharging before it is properly chambered. If this happens, the cartridge case may rupture and its fragments fly out of the ejection port of the pistol with sufficient force to cause serious injury. Always wear shooting glasses!</p>
	HITTING PRIMER CAN BURST CARTRIDGE

TO MINIMIZE MALFUNCTIONS ("JAMS" or "MISFIRES")

Alterations to the pistol or use of non-Ruger magazines and accessories may cause malfunctions. See "Warning - Alterations" on page 12.

1. If it appears that the jam was caused by the type of ammunition being used, try another brand, type, or lot number. Remember — use only new factory ammunition of the correct caliber.
2. Frequently clean and lubricate the pistol according to the instructions on p. 34. Use a bristle brush and solvent to remove fouling, paying particular attention to the breech-face, extractor, and chamber. Be careful not to over-lubricate.
3. Frequently inspect the firearm for wear or damage according to the instructions on p. 36.
4. Clean and inspect the magazine according to the instructions on p. 18 or try a different **GENUINE RUGER® FACTORY** magazine.
5. Make sure you are following the correct loading and firing sequence as described in this manual.
6. If none of the above steps is effective, contact the Ruger Customer Service Department for additional assistance. See "Service and Parts Policy," p. 38.

DISASSEMBLY Be sure pistol is unloaded!

 WARNING - DISASSEMBLY	
	<p>Always unload a firearm before cleaning, lubrication, disassembly or assembly.</p>
UNLOAD BEFORE DISASSEMBLY	

NOTE: An on-line video demonstrating the disassembly and reassembly of the **RUGER-5.7™** pistol can be viewed by going to Ruger.com/TechTips.

1. **Keep pistol pointed in a safe direction.** Press the magazine release and remove the magazine. (See Figure 13.)



2. Pull the slide to the rear and lock it into the open position by pressing upward on rear of the slide stop. (See Figure 14.) **Again, be sure the chamber is empty!** (See Figure 15.)

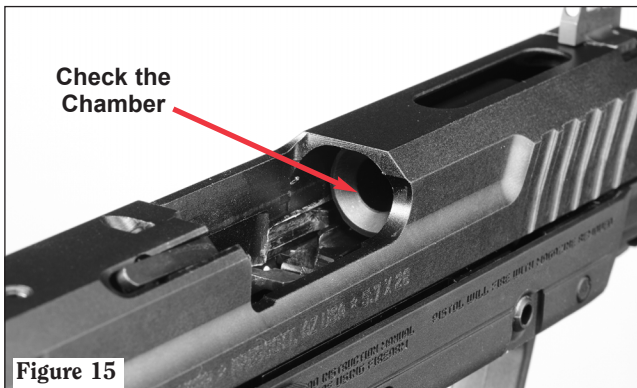

- Using the base pad of the magazine or a non-marring tool, press in slightly on the take-down button located on the right side of the grip frame just forward of the trigger (see Figure 16a). Then, turn the firearm over and rotate the take-down lever clockwise about 90 degrees (see Figure 16b.) Once resistance is met, the lever should not be rotated any further.

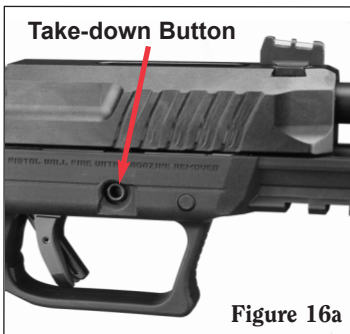

- Pull the slide rearward to release the slide stop and maintain control of the slide to gently guide it forward to release tension on the recoil spring. (See Figure 17.)



5. Remove the slide and barrel from the frame by sliding it carefully forward about $\frac{1}{4}$ inch (see Figure 18a) and lifting up on the rear of the slide (see Figure 18b) and remove the entire slide assembly from the frame (see Figure 18c).



6. Hold the top of the slide and slightly depress the recoil spring to disengage the guide rod/recoil spring assembly from its seat against the barrel lug. (See Figure 19.) Pull the guide rod assembly out of the slide.



7. With the slide still upside down, lift the barrel up and out of the slide. (See Figure 20.) Your pistol is now field stripped and ready for cleaning.



NOTE: Do not attempt further disassembly of your firearm. The firearm can now be cleaned and lubricated. There are no user serviceable parts below this level. If further disassembly is required, contact Ruger Customer Service.

NOTE: Do not dry fire while disassembled in order to prevent damage to the ejector.

REASSEMBLY

1. Be certain the chamber is empty. Always keep the pistol pointed in a safe direction.
2. With the slide held upside down, replace the barrel (see Figure 22) so that it sits against the breechface.



3. Place the guide rod/recoil spring assembly into position with the large round end of the assembly resting against the seat of the barrel lug (see Figure 23) and fully seated in the recess pocket in the barrel. (See Figure 24.)

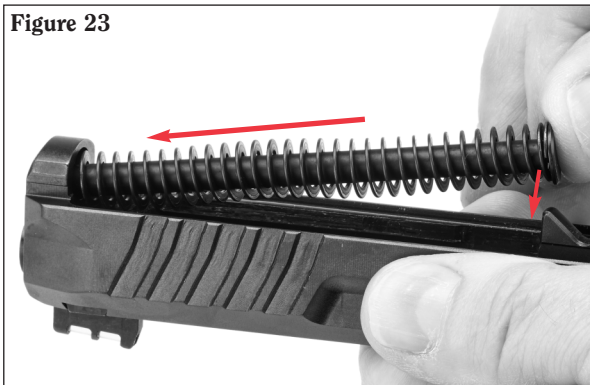

4. Center the barrel and guide rod assembly in the slide. (See Figure 26.)



5. Replace the slide onto the frame by setting it straight down, about ¼ inch forward of the normally closed position. (See Figure 25.)



6. Pull the slide fully back and lock it into position by pushing upward on the slide stop. (See Figure 26.)



7. First, make sure the barrel is in its most rearward position. Next, rotate the take-down lever counterclockwise until it stops in the horizontal position (see Figure 27). Press the takedown lever straight in toward the frame until you hear a click locking it in place.

NOTE: If the takedown lever does not move easily to the horizontal position, push on the barrel to ensure the barrel is fully seated to the rear.



8. Pull the slide rearward to drop the slide stop and allow the slide to move fully forward. (See Figure 28.)



Figure 28

CHECK YOUR PISTOL'S FUNCTION

Periodic inspection of any firearm is important to ensuring its safe operation. It is important to clean and inspect your firearm after each range session or whenever the firearm has been exposed to sand, dust, moisture, humidity, or other adverse conditions. Proper maintenance increases the longevity of your firearm and will allow early detection of worn or broken parts.

Prior to each use, visually inspect the firearm to ensure no components are damaged, missing, loose, bent, cracked, chipped, or peened. If you observe excessive wear, you should stop using your pistol and contact customer service or a trained certified gunsmith to evaluate its condition and replace any worn parts if necessary.

After reassembly and before using your pistol, you should perform a function check to ensure the pistol is properly reassembled and fully functional.

FIRST, BE SURE THERE IS NO AMMUNITION IN THE CHAMBER OR THE MAGAZINE AND KEEP THE PISTOL POINTED IN A SAFE DIRECTION!

CHECK THE FUNCTION OF THE SLIDE:

- Ensure you begin with an unloaded pistol. Point the pistol in a safe direction and remove the magazine; retract the slide; and lock it to the rear with the slide stop. **Visually inspect the chamber to ensure there is no ammunition present.**
- Release the slide and insert an empty magazine. Ensure the magazine snaps in place.
- Retract the slide. Once the slide moves all the way to the rear, the magazine follower should activate the slide stop and hold the slide to the rear.
- Remove the empty magazine.
- Pull back slightly on the slide. The slide stop should drop down out of the way. Release the slide. The slide should close fully on the empty chamber.

– Continued On Next Page –

CHECK THE FUNCTION OF THE TRIGGER:

- With the pistol held in a safe direction, press the trigger and hold it to the rear. You should hear a click as the internal hammer falls.
- With the trigger still held to the rear, fully retract and release the slide to simulate cycling.
- Release the trigger (you should hear a click as the trigger resets but the internal hammer should not fall).
- Press and release the trigger. You should hear a click as the internal hammer falls.

If your pistol fails any of these steps, follow the instructions for Disassembly, Cleaning, Inspection, and Reassembly. If the problem is not immediately resolved, contact Ruger Customer Service for assistance.

TO CLEAN AND LUBRICATE

Make Sure Firearm Is Unloaded!

As the pistol accumulates fouling from usage, or whenever the pistol has been exposed to sand, dust, extreme humidity, condensation, immersion in water, or other adverse conditions, disassemble, clean, and oil it. An on-line video demonstrating the proper cleaning procedure of the **RUGER-5.7™** pistol can be viewed by going to Ruger.com/TechTips. To clean the pistol, proceed as follows:

Make Sure Firearm Is Unloaded! Keep all ammunition and loaded magazines away from the pistol while cleaning.

1. Disassemble (fieldstrip) the pistol to the extent described on pages 26 - 30.
2. To clean the barrel, run a cleaning rod with a properly sized solvent-wetted patch through the bore several times. Then, attach a .22 caliber or .223 caliber copper brush to the cleaning rod and wet it with solvent. Run the brush back and forth the full length of the barrel as many times as necessary to remove fouling from the bore. To clean the chamber, use a 7mm or .30 cal copper brush with solvent to scrub the chamber. After brushing, clean the bore with dry patches to remove the solvent and examine. Repeat until clean, then run a lightly oiled patch through the bore and chamber to lubricate. Finally, run one more dry patch through the bore and chamber to remove excess lubricants. Excess lubricants in the barrel and chamber attract and hold dust and can interfere with proper functioning.
3. To clean the slide, grip frame, and recoil spring, use a plastic-safe firearm cleaning solvent. Wet a bristle brush with solvent to remove excess lubricants and fouling. Pay close attention to cleaning the breech face, extractor and slide rails. After cleaning, remove excess solvent with a clean lint-free cloth, then wipe all metal surfaces with a patch or cloth that has been very lightly oiled as a rust preventative.

Important – Excess accumulations of oil tend to attract particles of dust and dirt and may congeal in cold weather, which can interfere with the safe and reliable function of the pistol. Do not over-lubricate the pistol.

4. **Lubrication.** Apply a very small amount of appropriate lubricant to reduce friction in key areas, including the front and rear pairs of slide rails on the frame insert (see Figure 29); the barrel lug, and the area of contact between the hammer spring and the hammer (see Figure 30); and the “clicking” feature of the locking cam. The “clicking” feature is visible when the locking cam is rotated 90° counterclockwise (see Figure 31).

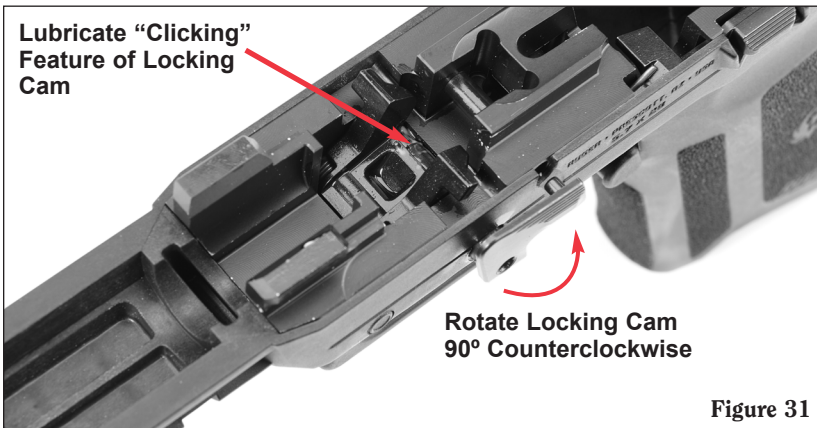
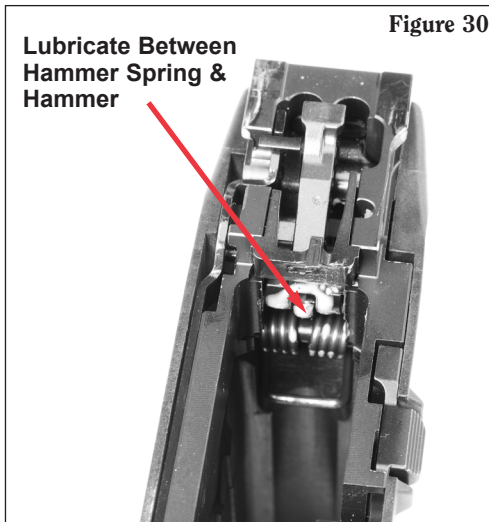
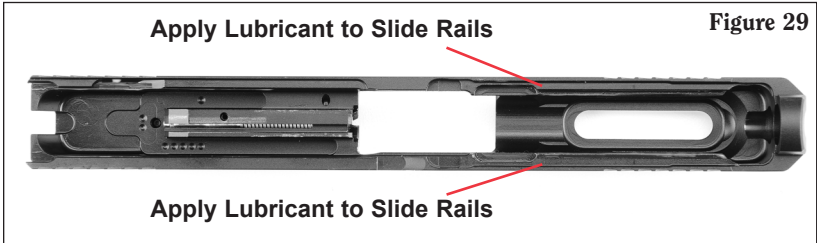

 <h2 style="margin: 0;">WARNING - LUBRICATION</h2>	
	<p>Firing a pistol with oil, grease, or any other material even partially obstructing the bore may result in damage to the pistol and serious injury to the shooter and those nearby. Do not spray or apply lubricants directly on ammunition. If the powder of a cartridge is affected by the lubricant, it may not be ignited, but the primer firing may push the bullet into the bore where it may be lodged. Firing a subsequent bullet into the obstructed bore may damage the pistol and cause serious injury or death to the shooter and those nearby. Use lubricants properly. You are responsible for the proper care and maintenance of your firearms.</p>
<h3>IMPROPER LUBRICATION DESTROYS FIREARMS</h3>	

INSPECTION AND MAINTENANCE

Firearms are exposed to extreme heat and stress. The proper care of any firearm should always include periodic inspection for worn or broken parts to protect your investment and ensure a lifetime of safe shooting. A firearm with worn-out or broken parts may continue to function, however it will eventually fail or become unsafe to shoot. Clean and inspect your pistol after each range session and replace worn parts as needed.

Disassemble and clean your pistol in accordance with the instructions found in this Instruction Manual. Before lubricating, visually inspect the entire pistol for damaged or missing components. A scuffed or shiny appearance in high friction areas is normal. Cracks, burrs, and peening are indicators that parts need to be replaced to prevent further deterioration from occurring.

Common replacement parts may be purchased on ShopRuger.com. Additional **GENUINE RUGER® FACTORY** parts can also be ordered through Ruger Customer Service. After replacing any worn out parts, lubricate, reassemble, and perform a function check as outlined in this Instruction Manual on the unloaded firearm to ensure it operates properly and verify that all safety devices are in proper working order.

If you have any questions or concerns about the safe operation of your firearm, contact Ruger Customer Service or your local trained and certified gunsmith.

SIGHT ADJUSTMENT

For models equipped with a click-adjustable rear sight, windage and elevation may be adjusted by using a small, flat-tipped screwdriver.

Adjust windage by turning the small, flat-headed screw on the right side of the rear sight. Turning the windage adjustment screw clockwise will adjust the point of impact to the right, and turning it counterclockwise will adjust the point of impact to the left.

Adjust elevation by turning the small, flat-headed screw on top of the rear sight. Turning the elevation adjustment screw clockwise will adjust the point of impact down, and turning it counterclockwise will adjust the point of impact up.

NOTE: Rear sight adjustment may be needed when switching ammunition types.

ACCESSORY OPTICS

In addition to the equipped sights, the top of the slide is drilled and tapped for use with optic adapter plates, which are available from ShopRuger.com.

NOTE: Optics that weigh more than 1 oz. may cause short cycling or other function-related issues, particularly when using 27 grain ammunition.

The optic adapter plate holes in the top of the slide are factory-equipped with filler screws. Be sure to remove both filler screws prior to installing any optic adapter plate or optic. If you decide to remove the optic adapter plate, the filler screws must be reinstalled. **NOTE:** The filler screws should never be screwed in beyond the point where the screw head is flush with the top of the slide, as doing so may cause malfunctions.



STORAGE

FIREARMS SHOULD NOT BE STORED LOADED!

**USE THE LOCKING DEVICE SUPPLIED WITH THE PISTOL
TO RENDER IT INOPERATIVE FOR SAFE STORAGE.**

(SEE PAGE 10)

Do not keep your pistol in a leather, fabric, or canvas holster when it is stored. These materials attract moisture, even though the holster may appear to be perfectly dry.

 WARNING – STORAGE	
	<ul style="list-style-type: none">• Never place or store any firearm in such a manner that it may be dislodged. Firearms should always be stored securely and unloaded, away from children and careless adults.• Use the locking device supplied with the pistol for storage. The use of a locking device or safety lock is only one aspect of responsible firearms storage.• For increased safety, firearms should be stored unloaded in a location that is both separate from their ammunition and inaccessible to children and any other unauthorized person.
STORE SECURELY & UNLOADED	

SERVICE AND PARTS POLICY

If you have any questions with regard to the performance of your **RUGER-S.7™** pistol please contact our Customer Service online at **Ruger.com** or call the Customer Service Dept. at 336-949-5200. Fully describe all circumstances and conditions involved. If you should return your firearm to the factory for repair, or order parts for it, please comply with the following suggestions for prompt service:



WARNING—BEFORE SHIPPING ANY FIREARM, BE ABSOLUTELY CERTAIN THAT IT AND ITS MAGAZINE ARE UNLOADED. DO NOT SHIP CARTRIDGES WITH A FIREARM.

SHIPPING FIREARMS FOR REPAIR:

NOTE: You must obtain a Repair Authorization Number before returning your firearm. An authorization number can be obtained by contacting Customer Service online at **Ruger.com** or calling the Customer Service Department at 336-949-5200. Firearms should be sent prepaid. We will not accept collect shipments. Any **RUGER-S.7™** pistol returned to the factory for repair should be sent to: Sturm, Ruger & Company, Inc., Customer Service Department, 200 Ruger Road, Prescott, AZ 86301-6181.

The Federal Gun Control Act, as well as the laws of most states and localities, do not prohibit an individual (who is not otherwise barred from purchasing or possessing a firearm) from shipping a firearm directly to the manufacturer for repair. However, before you ship your firearm to us, be certain that your state or locality does not have a law or regulation which will prohibit you from receiving the firearm (or any included magazines) from us after it has been repaired. If such receipt is prohibited, please have a federally licensed firearms dealer ship the firearm to us. If your firearm is sent to us by a dealer, it will be returned to that dealer after being repaired. If a handgun (pistol or revolver) is shipped by an individual who does not hold a Federal Firearms License, it must be shipped for overnight delivery via U.P.S., Federal Express, or other, similar private overnight service. **NOTE:** Handguns may not be shipped via U.S. Mail. Persons who do not hold a Federal Firearms License are prohibited by Federal law from shipping a handgun by Mail. Handguns mailed in violation of the law may be impounded or confiscated by the Post Office and the non-FFL may be subject to prosecution.

Please do not include holsters, custom grip panels, or accessories with a firearm being shipped to the factory for service. **DO NOT SEND FIREARM BOXES OR LITERATURE THAT YOU CONSIDER TO BE COLLECTOR'S ITEMS – THESE ARE INVARIABLY DAMAGED OR DESTROYED IN SHIPMENT.** Always insure your shipment.

Enclose a letter which includes your name, address, telephone number, firearm serial number and model, and repair authorization number. Describe in detail the trouble you have experienced with your firearm, or the work you wish to have done. Merely stating that the firearm “needs repair” is inadequate information. Please enclose copies of any previous correspondence.

All work performed is subject to a minimum labor charge and charges for shipping and handling. Most models can be reblued, but custom gunsmithing service or nonstandard alterations are NOT AVAILABLE from Ruger Customer Service Departments. Please contact the Customer Service Department for pricing information. In states that have a magazine capacity limitation, DO NOT RETURN so-called high capacity magazines as Ruger may not be able to return the magazine to you.

 WARNING – PARTS PURCHASERS	
	<ul style="list-style-type: none">• It is the purchaser's responsibility to be absolutely certain that any parts ordered from the factory are correctly fitted and installed.• Firearms are complicated mechanisms and IMPROPER FITTING OF PARTS MAY RESULT IN A DANGEROUS MALFUNCTION, DAMAGE TO THE FIREARM, AND SERIOUS INJURY TO THE SHOOTER AND OTHER PERSONS.• The purchaser and installer of parts must accept full responsibility for the correct adjustment and functioning of the firearm after such installation.
PARTS MUST FIT CORRECTLY	

ORDERING PARTS

Please contact the Prescott, Arizona Customer Service Department for parts availability and current prices. All parts orders for the **RUGER-5.7™** pistols should be sent to: Sturm, Ruger & Company, Inc., Customer Service Department, 200 Ruger Road, Prescott AZ 86301-6181, 336-949-5200. We cannot comply with open account or C.O.D. requests. Payment in full via credit card (Visa, MasterCard, or Discover only), money order or certified bank check (no personal checks or cash, please) is required before any service will be performed. Please provide your credit card number, your name as it appears on the credit card, the expiration date, and the 3-digit security code. All parts orders are subject to a minimum charge and charges for shipping and handling. Order parts by **Part Name and specify the model and entire serial number** of the firearm for which the parts are being ordered. There is a minimum labor charge plus a shipping and handling charge if the parts are factory fit. All factory fit parts are fit on an exchange basis only. We will not return the replaced parts. Please contact the Customer Service Department for pricing information.

Because it is a serial numbered component, the **RUGER-5.7™** pistol frame insert is defined as a “firearm” by Federal law and is not sold as a separate component.

NOTE: Although the **RUGER-5.7™** is designed for parts to be interchangeable, it is **NOT** recommended that customers disassemble the pistol beyond the field stripping described on pages 26 - 30. If your **RUGER-5.7™** requires replacement parts or service, it is strongly recommended that you return the pistol to Ruger Customer Service for inspection and repair. (See page 38.)



WARNING: A firearm containing broken, malfunctioning or badly worn parts should not be fired!

RUGER-5.7™

PRO MODEL PISTOL

PARTS LIST

Design, prices and specifications subject to change without notice.

SPECIFY MODEL, CALIBER, AND SERIAL NO. WHEN ORDERING

(See Exploded View on Page 41)

Key No.	Part Name	Key No.	Part Name
1	Slide	23	Inner Trigger Spring
2	Barrel	24	Trigger Pivot Pin
3	Recoil Spring/Guide Rod Assembly	25	Inner Trigger Pivot Pin
4	Front Sight	26	Hammer Spring
5	Rear Sight	27	Trigger Bar
6	Extractor	28	Spring, Sear
7	Extractor Pivot Pin	29	Spring, Locking Cam
8	Extractor Spring	30	Hammer Pin
9	Firing Pin	31	Hammer Spring Pin
10	Firing Pin Spring	32	Locking Cam/Barrel Pin, 2 Req'd
11	Firing Pin/Extractor Pin	33	Slide Stop
12	Grip Frame	34	Slide Stop Spring
13	Magazine Latch Thumb Piece	35	Takedown Lever Detent Plunger
14	Magazine Latch	36	Takedown Lever Detent Spring
15	Magazine Latch Spring	37	Trigger Pivot
16	Magazine Latch Pivot Pin	38	Trigger Spring
† 17	Fire Control Insert	39	Ejector
18	Hammer	40	Frame Insert Pin
19	Sear	41	Takedown Lever
20	Locking Cam	42	Magazine
21	Trigger, Outer	43	Sear Pivot Pin
22	Trigger, Inner		

† Because the Fire Control Insert is a serial-numbered component, it is defined as a “firearm” by Federal law and is not sold as a separate component.

NOTE: Although the **RUGER-5.7™** is designed for parts to be interchangeable, it is **NOT** recommended that customers disassemble the pistol beyond the field stripping described on pages 26 - 30. If your **RUGER-5.7™** requires replacement parts or service, it is strongly recommended that you return the pistol to Ruger Customer Service for inspection and repair. (See page 38.)

RUGER-5.7™ PRO MODEL PISTOL EXPLODED VIEW

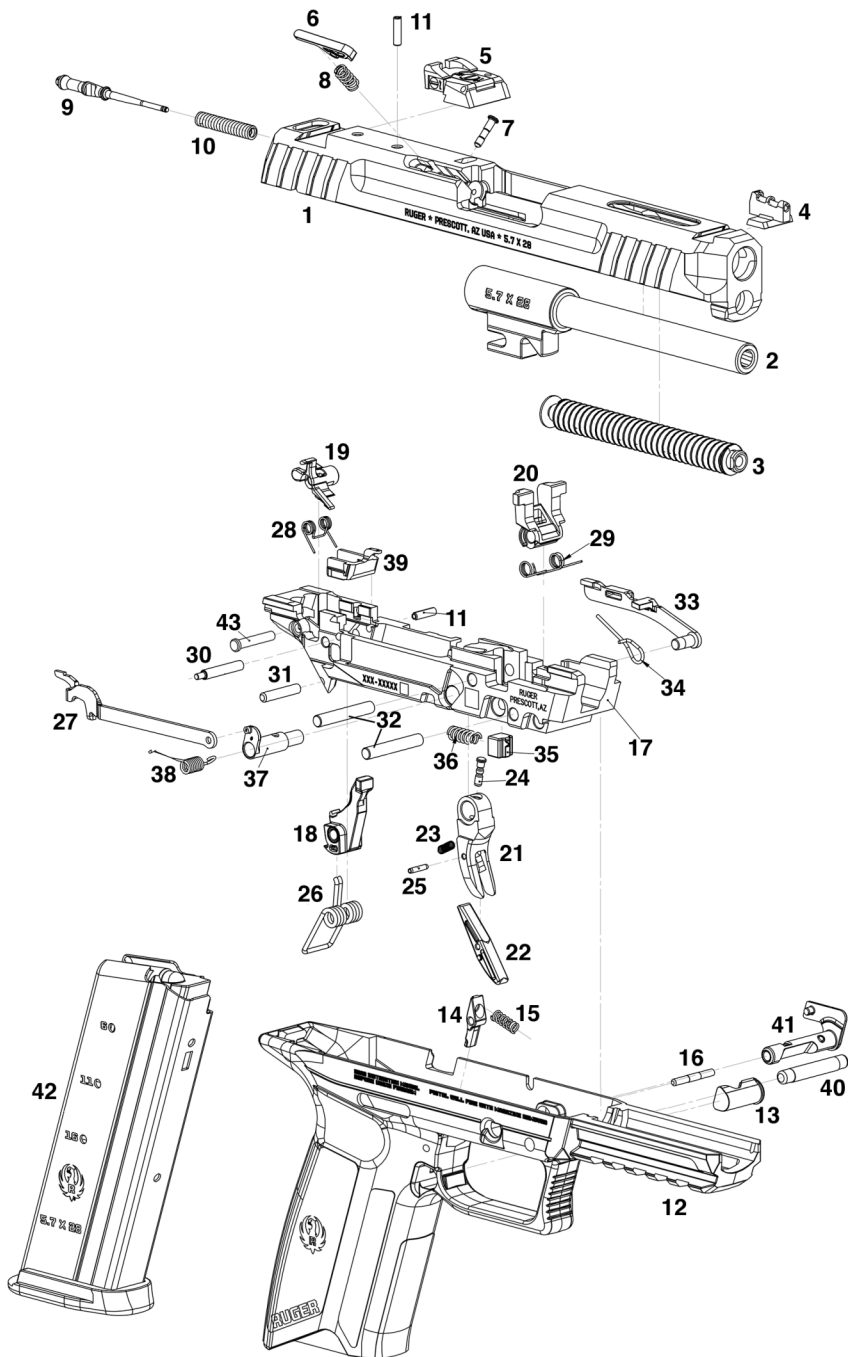

THE BASIC RULES OF SAFE FIREARMS HANDLING

We believe that Americans have a right to purchase and use firearms for lawful purposes. The private ownership of firearms in America is traditional, but that ownership imposes the responsibility on the gun owner to use his firearms in a way which will ensure his own safety and that of others. When firearms are used in a safe and responsible manner, they are a great source of pleasure and satisfaction, and represent a fundamental part of our personal liberty.

Firearms do not cause accidents! Firearms accidents are almost always found to have been the result of carelessness or ignorance on the part of the shooter of the basic rules of safe gun handling.

The following rules must be observed by gun users at all times. Safe gun handling is not just desirable, it is absolutely essential to your safety, the safety of others, and the continuation of gun ownership and sport shooting as we know it today.

1. LEARN THE MECHANICAL AND HANDLING CHARACTERISTICS OF THE FIREARM YOU ARE USING.



Not all firearms are the same. The method of carrying and handling firearms varies in accordance with the mechanical provisions for avoiding accidental discharge and the various proper procedures for loading and unloading. No person should handle any firearm without first having thoroughly familiarized himself with the particular type of firearms he is using, and with safe firearm handling in general.

2. ALWAYS KEEP THE MUZZLE POINTED IN A SAFE DIRECTION.



Be sure of the bullet stop behind your target, even when dry-firing. Never let the muzzle of a firearm point at any part of your body or at another person. This is particularly important when loading or unloading a firearm. In the event of an accidental discharge, no injury can occur as long as the muzzle is pointing in safe direction. A safe direction means a direction that will not permit a discharged bullet to strike a person, or to strike an object from which the bullet may ricochet.

A safe direction must take into account the fact that a bullet may penetrate a wall, ceiling, floor, window, etc., and strike a person or damage property. Make it a habit to know exactly where the muzzle of your gun is pointing whenever you handle it, and be sure that you are always in control of the direction in which the muzzle is pointing, even if you fall or stumble. Keep your finger off the trigger until you are ready to shoot.

3. FIREARMS SHOULD BE UNLOADED WHEN NOT IN USE.

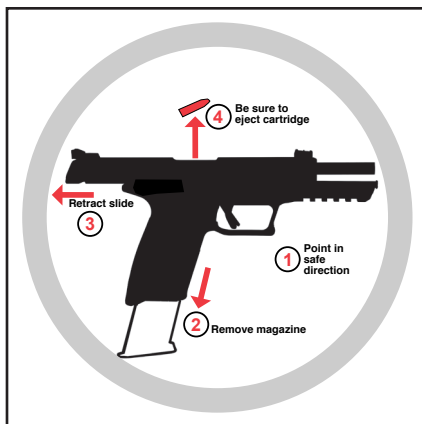

Firearms should be loaded only when you are in the field or on the target range or shooting area, ready to shoot. Firearms and ammunition should be securely locked in safes, racks or cabinets, or by using the locking device supplied with the firearm when not in use. Ammunition should be safely stored separate from firearms. Store your firearms out of sight of visitors and children. It is the gun owner's responsibility to be certain that children and persons unfamiliar with firearms cannot gain access to firearms, ammunition, or components.

4. BE SURE THE BARREL IS CLEAR OF OBSTRUCTIONS BEFORE SHOOTING.

Even a bit of mud, snow or excess lubricating oil or grease in the bore may cause the barrel to bulge, or even burst on firing, and can cause injury to the shooter and bystanders. Be sure that you are using ammunition of the proper caliber and loading for the gun you are using. If the report or recoil on firing seems weak, or doesn't seem quite right, CEASE FIRING IMMEDIATELY, unload your firearm, and check to be sure that no obstruction has become lodged in the barrel. Never try to shoot an obstruction out!





5. BE SURE OF YOUR TARGET BEFORE YOU SHOOT.

Don't shoot unless you know exactly where your bullet is going to strike. Be sure of the bullet stop behind your target, even when dry-firing with an unloaded gun. If you are in the field hunting, do not fire at a movement or noise. Take the time to be absolutely certain of your target before you pull the trigger.

6. WEAR SHOOTING GLASSES AND HEARING PROTECTION WHEN YOU SHOOT.

All shooters should wear protective shooting glasses and adequate hearing protection when shooting. Exposure to shooting noise can damage hearing, and wearing adequate eye protection when shooting is essential.



7. NEVER CLIMB A TREE OR FENCE WITH A LOADED FIREARM.

Put the firearm down carefully before climbing a fence, and unload it before climbing or descending a tree or jumping over a ditch or other obstruction. Never pull or push a loaded firearm toward yourself or another person. When in doubt, or whenever you are about to do anything awkward, unload your gun!

8. DON'T SHOOT AT A HARD SURFACE OR AT WATER.

Bullets can glance off many surfaces like rocks or the surface of water and travel in unpredictable directions with considerable velocity.



9. NEVER TRANSPORT A LOADED FIREARM.

Firearms should always be unloaded before being moved or placed in a vehicle. A suitable carrying case or scabbard should be used to carry an unloaded firearm to and from the shooting area.

10. AVOID ALCOHOLIC BEVERAGES WHEN SHOOTING.

Don't drink until the day's shooting is over. Handling firearms while under the influence of alcohol in any form, or medications that could affect your judgement or coordination, constitutes a criminal disregard for the safety of others.



A BRIEF ACCOUNT OF AN EXTRAORDINARY ACHIEVEMENT: RUGER® FIREARMS

Sturm, Ruger & Company, Inc., had its beginning in a small machine shop occupying a rented frame building in Southport, Connecticut. In January, 1949, with an initial investment of only \$50,000 and an idea, William B. Ruger and Alexander M. Sturm started production of a .22 caliber autoloading pistol—a design which was so successful that it became the cornerstone upon which one of the most comprehensive lines of sporting firearms ever made in America was established. After Alex Sturm's death in 1951, William B. Ruger continued to direct the Company until his death in 2002. William B. Ruger, Jr. continued to provide guidance, which helped make this Company a sound and successful enterprise, until his retirement in 2006. The Company has continued to prosper, under new management and guidance from our Board, with new products and fresh perspectives.

Ruger, in this relatively short time, has established itself as a leading small arms design organization, developing a unique and broad line of fine quality sporting, military and police firearms to become one of the world's most famous producers of revolvers, pistols, rifles and shotguns. Since 1949, Ruger craftsmen have built many millions of firearms.

During its five decades of growth and progress under the leadership of William B. Ruger, the Company developed a business philosophy and implemented policies which represent a constructive influence in the life of modern America. From the beginning, Ruger played a positive role in conservation efforts and has supported the interests of shooters through such groups as the National Rifle Association, National Shooting Sports Foundation, and many regional sportsmen's organizations.

The Company has always endeavored to market its firearms for constructive and recreational purposes, to emphasize the traditional and responsible aspects of shooting, to render meaningful public services, and to encourage shooters in constructive, responsible, and safe participation in the shooting sports. Its motto, "Arms Makers For Responsible Citizens®," exemplifies this Company philosophy.

Today, Ruger® is particularly mindful of those elements which have contributed to the creation of its success, and extends heartfelt thanks to its many loyal employees and customers.

The firearms catalog, and instruction manuals for all Ruger® firearms, can be downloaded from our website at:

Ruger.com

NOTES

WHY NO WARRANTY CARD HAS BEEN PACKED WITH THIS NEW RUGER® FIREARM

The Magnuson-Moss Act (Public Law 93-637) does not require any seller or manufacturer of a consumer product to give a written warranty. It does provide that if a written warranty is given, it must be designated as "limited" or as "full" and sets minimum standards for a "full" warranty. Sturm, Ruger & Company, Inc. has elected not to provide any written warranty, either "limited" or "full", rather than to attempt to comply with the provisions of the Magnuson-Moss Act and the regulations issued thereunder. There are certain implied warranties under state law with respect to sales of consumer goods. As the extent and interpretation of these implied warranties varies from state to state, you should refer to your state statutes. Sturm, Ruger & Company wishes to assure its customers of its continued interest in providing service to owners of Ruger® firearms.



STURM, RUGER & COMPANY, INC.

200 Ruger Road

Prescott, Arizona 86301 U.S.A.

Ruger.com

Arms Makers For Responsible Citizens®

**A COPY OF THE INSTRUCTION MANUAL FOR ANY RUGER®
FIREARM IS AVAILABLE FROM THE FACTORY FREE ON REQUEST, OR IT MAY BE
DOWNLOADED FROM OUR WEBSITE AT RUGER.COM.
THESE INSTRUCTION MANUALS CONTAIN IMPORTANT
WARNINGS WHICH MUST BE UNDERSTOOD
BEFORE USING THESE FIREARMS.**

The Following are Sturm, Ruger & Co., Inc. Trademarks: "All-Weather," "Bisley," "Gold Label," "I'm a Ruger American," "LC6," "LCR-357," "LC380CA," "Mark II," "Mark III," "Mark IV," "MAX-9," "Model 96," "P345," "P345D," "P345PR," "P85," "P89," "P90," "P91," "P93," "P94," "P95," "P97," "PC Carbine," "R.I.O.S.," "Ruger-5.7," "Ruger Marksman Adjustable," "Ruger 77/50," "Ruger 10/17," "Security-Six," "Service-Six," "77/357," "Single-Seven," "Speed-Six," "SR45," "SR-556C," "SR-556VT," "Super Bearcat," "Target Grey," "10/22-FS," "This is Ruger. This is America," "Tri-Flex," "22 Charger," "22/45," "22/45 RP," and "Your Next Handgun."

The Following are Registered U.S. Trademarks Belonging to Sturm, Ruger & Co., Inc.: "AC-556," "AR-556," "Arms Makers For Responsible Citizens," "Bearcat," "Blackhawk," "BX-15," "BX-25," "BX-Trigger," Eagle - solid logo design, Eagle Hard "R" logo holding gun, Eagle 'R' - soft 'R' & hard 'R' logo design, Eagle w/SR, Eagle w/soft 'R' linear logo design, Eagle w/hard 'R' linear logo design, Eagle w/soft 'R' stacked logo design, Eagle w/hard 'R' stacked logo design, Eagle w/soft 'R' linear logo design & "Rugged, Reliable Firearms" below logo, Eagle w/hard 'R' linear logo design & "Rugged, Reliable Firearms" below logo, "EC9s," "Elite 452," "GP100," "Hawkeye," "It's Mine and It's American," "It's Mine. And It's American," "LC380," "LC9," "LC9s," "LC9s Pro," "LCP," "LCR," "LCRx," "M77," "Match Champion," "Mini-14," "Mini Thirty," "9E," "Old Army," "Power Bedding," "Redhawk," "RUGER," "Ruger American," "Ruger American Pistol," "Ruger American Pistol" flag design, "Ruger American Rifle," "Ruger American Rimfire," "Ruger Custom Shop," "Ruger Hunting" - phrase & logo design, "Ruger Precision," "Ruger Precision Rifle" - phrase & logo design, "Ruger 77/17," "Ruger 77/22," "Ruger 77/44," "Ruger SP101," "Ruger 10/22 Takedown" phrase & logo design, "Ruger Titanium," "Ruger 22/45 Lite," "Ruger Vaquero," "Rugged, Reliable Firearms," "Security-9," "Silent-SR," "Single-Nine," "Single-Six," "Single-Ten," the "SR" Design, "SR9," "SR9c," "SR40," "SR40c," "SR-22," "SR22," "SR-556," "SR-556 Takedown," "SR-762," "SR1911," "Super Redhawk Alaskan," "10/22," & "Wrangler."